



Cleaning



- You can just rinse off pollen, sand, and dust with some water (from a hose or watering can).
- For stubborn dirt, use a lint-free cloth or a soft sponge with plenty of water and a light touch.
- To get rid of really tough grime, use warm water and a bit of regular dish soap.



Stuff you should avoid:

- Don't rub your SunForm dry.
- Don't use any abrasive cleaners.
- Glass cleaners, solvents, and alcohol can damage the surface.
- Don't use a pressure washer.

More info

... can be downloaded from the service area of the SunForm shop

(www.sunform.shop/service/).

- Setup & Positioning
- Cleaning & Care
- Tips & Tricks

Safety warnings



SunForms aren't toys and aren't suitable for kids under 3.
The mounting kit might contain small parts - **choking hazard**.

If you use brute force (like bending it too much or hitting it hard), the plastic discs might break or splinter. Broken edges can be sharp or pointy and might cause cuts or stabs if you're not careful.

In that case, please wear proper gear (like safety goggles and gloves).

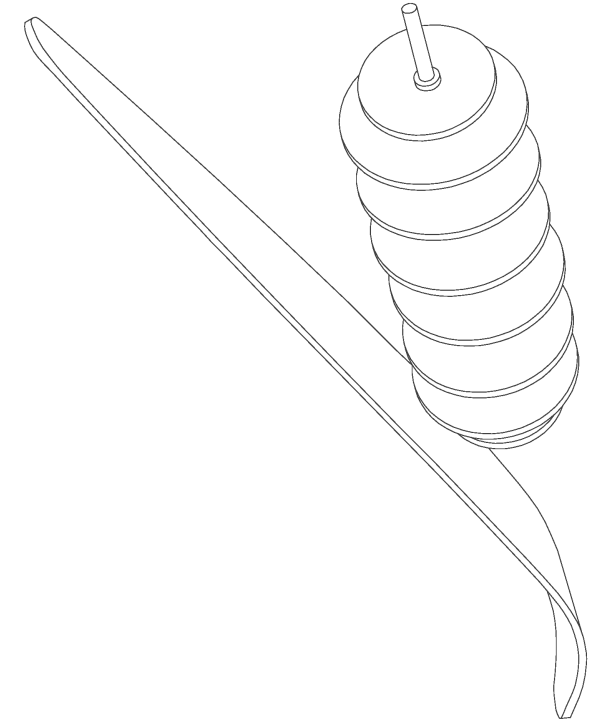

Content

- What's in the box
- General tips
- Assembly guide
- Setting it up
- Cleaning
- More info
- Safety warnings

What's in the box

- 1x Reed leaf
- 6x large and 2x small discs
- 1x Flexible fiberglass swing rod
- 1x Assembly guide
- 1x Mounting kit

General tips

- SunForms are generally winter-proof and can handle temperatures up to 75 °C.
- The discs come wrapped in protective film. For quality checks or with frosted, engraved, or coated discs (MultiColor), the film is removed during production.
- **To keep the film from tearing on delicate engravings or thin edges, please peel it off nice and slow.**

Assembly Guide

To put your SunForm together, you'll need:

 a damp cloth

 and a tape measure.

1. First, twist the clips into the holes of the round discs.

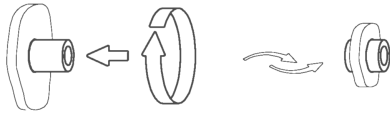

2. Moisten the rod and slide a locking clip into position above where the leaf will go (you can use a clothespin to help push it along).

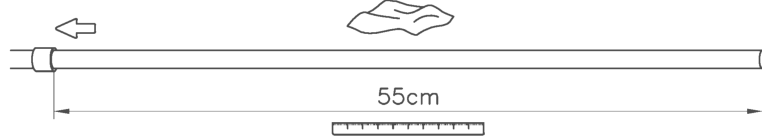

3. Now, slide or twist one small disc, six large ones, and then another small disc into place (just check the sketch next to this for the exact spots). Keep the rod wet while you do this. Once they're on, pop the protective cap onto the end of the rod.

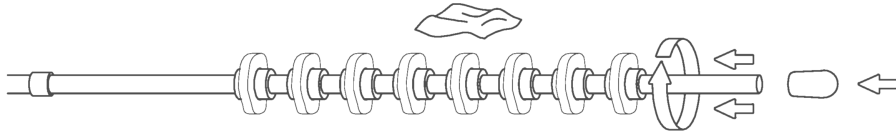

4. Carefully bend the reed leaf and guide it over the rod from the bottom until it reaches the locking clip you positioned earlier. Moisten the rod one more time and slide the second locking clip up until it meets the leaf.

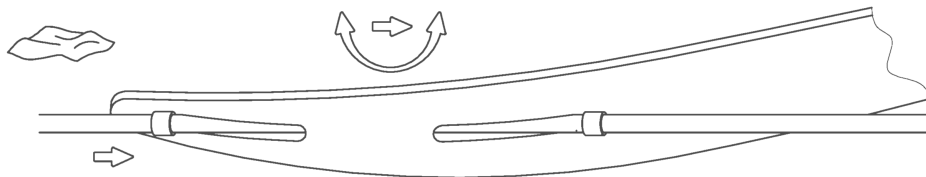

As long as the rod is still wet, you can easily adjust the discs by sliding or twisting them. After a few days, any moisture between the rod and the clips will have dried up. This is when the discs will be firmly locked into their final position.

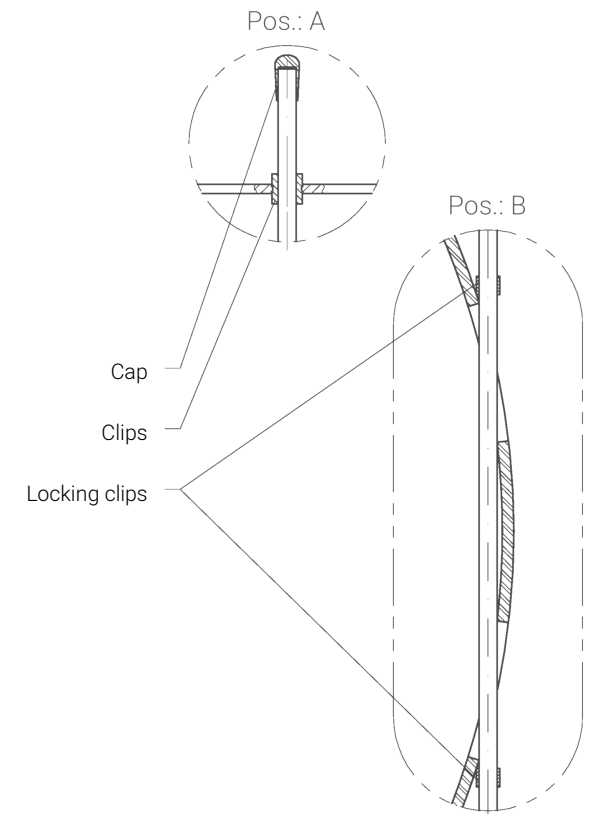
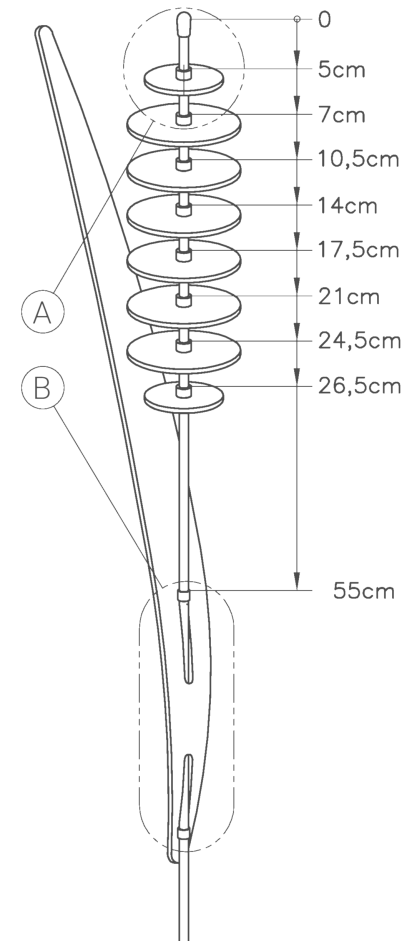

Setting it up

Sun catchers actually like shady spots best. So, it's better not to place your sun catcher in direct sunlight. In direct sun, everything looks so bright that your eyes can't really pick up the subtle differences in glow anymore.

You can just stick the rod for this SunForm straight into the ground. If the ground is hard and it's not too windy, about 15 cm deep is fine. If the soil is soft or you're expecting stronger winds, the rod should go about 20 to 25 cm deep.

Make sure the vibrations don't loosen the dirt and widen the hole over time. This would make the whole thing less stable. If that happens, just pull the rod out and stick it back in a slightly different spot.