



Cleaning



- You can just rinse off pollen, sand, and dust with some water (from a hose or watering can).
- For stubborn dirt, use a lint-free cloth or a soft sponge with plenty of water and a light touch.
- To get rid of really tough grime, use warm water and a bit of regular dish soap.



Stuff you should avoid:

- Don't rub your SunForm dry.
- Don't use any abrasive cleaners.
- Glass cleaners, solvents, and alcohol can damage the surface.
- Don't use a pressure washer.

More info

... can be downloaded from the service area of the SunForm shop

(www.sunform.shop/service/).

- Setup & Positioning
- Cleaning & Care
- Tips & Tricks

Safety warnings



SunForms aren't toys and aren't suitable for kids under 3.
The mounting kit might contain small parts - **choking hazard**.

If you use brute force (like bending it too much or hitting it hard), the plastic discs might break or splinter. Broken edges can be sharp or pointy and might cause cuts or stabs if you're not careful.

In that case, please wear proper gear (like safety goggles and gloves).



Content

- What's in the box
- General tips
- Assembly guide
- Setting it up
- Cleaning
- More info
- Safety warnings

What's in the box

- 1x Sail
- 1x Surfboard
- 1x Wave
- 1x Flexible fiberglass swing rod
- 1x Assembly guide
- 1x Mounting kit

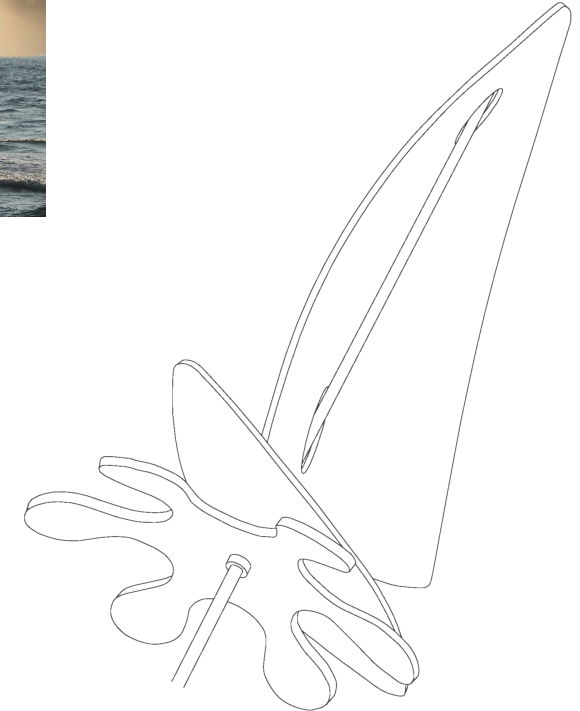

General tips

- SunForms are generally winter-proof and can handle temperatures up to 75 °C.
- The discs come wrapped in protective film. For quality checks or with frosted, engraved, or coated discs (MultiColor), the film is removed during production.
- **To keep the film from tearing on delicate engravings or thin edges, please peel it off nice and slow.**
- The discs are heated up to be bent into shape. This can cause some bubbles to form under the protective film. Don't worry, though—those bubbles disappear when you peel off the film and don't affect the quality of the discs at all.

Assembly Guide

To put your SunForm together, you'll need:

 a damp cloth

 and a tape measure.

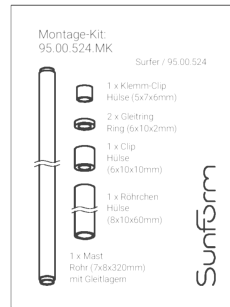

1. Screw the clip into the wave and then twist the little tube (from the top) about 1 cm into the surfboard.

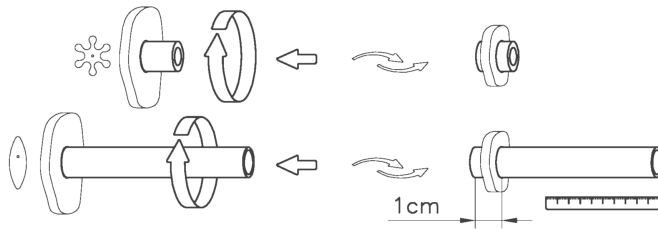

2. Wet the rod a little and then twist or slide the wave into its spot.

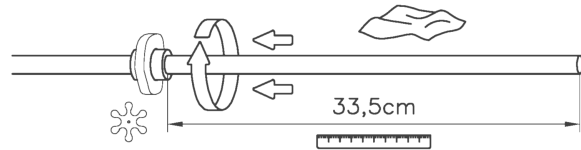

3. Moisten the mast and push it all the way into the tube attached to the surfboard.

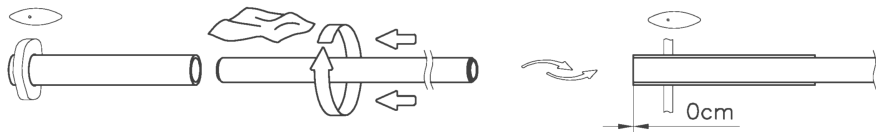

4. Slide the two sliding rings and the mast (with the surfboard) over the rod from the top.



5. Pop the locking clip onto the top end of the rod, leaving a bit of space from the mast. Feel free to nudge the wave a bit if you need more room.

6. Now, bend the sail and guide it over the mast and the tube with the surfboard.

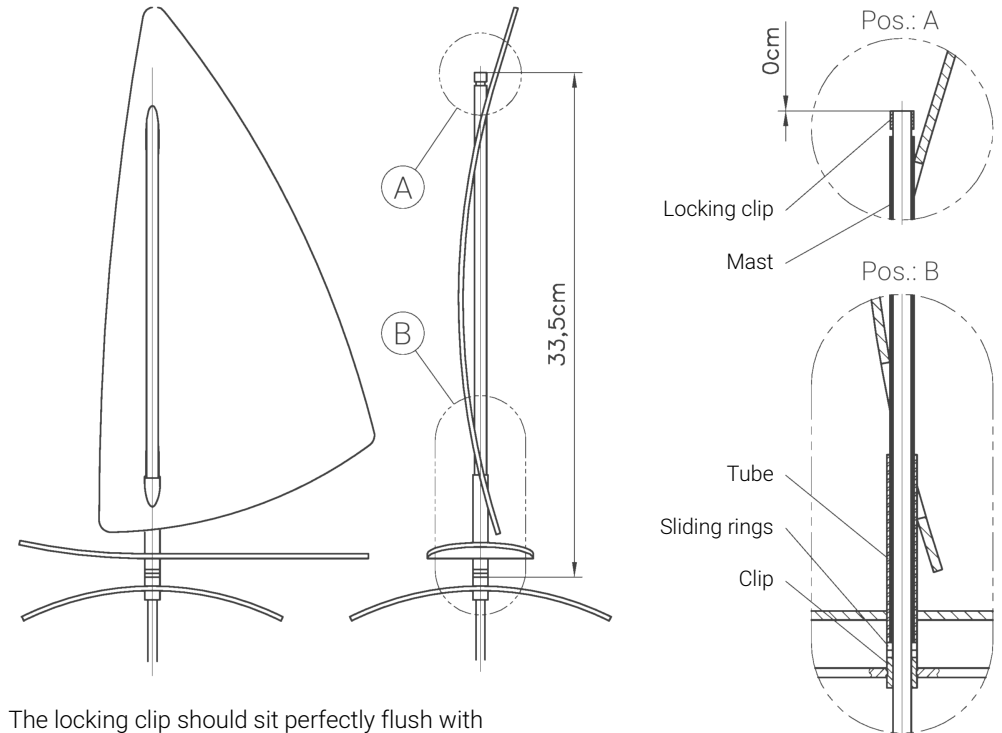
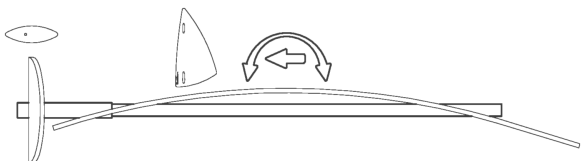

The locking clip should sit perfectly flush with the very top of the rod.

Setting it up

Sun catchers actually like shady spots best. So, it's better not to place your sun catcher in direct sunlight. In direct sun, everything looks so bright that your eyes can't really pick up the subtle differences in glow anymore.

You can just stick the rod for this SunForm straight into the ground. If the ground is hard and it's not too windy, about 15 cm deep is fine. If the soil is soft or you're expecting stronger winds, the rod should go about 20 to 25 cm deep.

Make sure the vibrations don't loosen the dirt and widen the hole over time. This would make the whole thing less stable. If that happens, just pull the rod out and stick it back in a slightly different spot.

If you need extra stability, you can also use the matching ground anchor (accessory / item no.: 95.00.201.XXX).

