



## Cleaning



- You can just rinse off pollen, sand, and dust with some water (from a hose or watering can).
- For stubborn dirt, use a lint-free cloth or a soft sponge with plenty of water and a light touch.
- To get rid of really tough grime, use warm water and a bit of regular dish soap.



### Stuff you should avoid:

- Don't rub your SunForm dry.
- Don't use any abrasive cleaners.
- Glass cleaners, solvents, and alcohol can damage the surface.
- Don't use a pressure washer.

## More info

... can be downloaded from the service area of the SunForm shop

([www.sunform.shop/service/](http://www.sunform.shop/service/)).

- Setup & Positioning
- Cleaning & Care
- Tips & Tricks

## Safety warnings



SunForms aren't toys and aren't suitable for kids under 3.  
The mounting kit might contain small parts - **choking hazard**.

If you use brute force (like bending it too much or hitting it hard), the plastic discs might break or splinter. Broken edges can be sharp or pointy and might cause cuts or stabs if you're not careful.

In that case, please wear proper gear (like safety goggles and gloves).

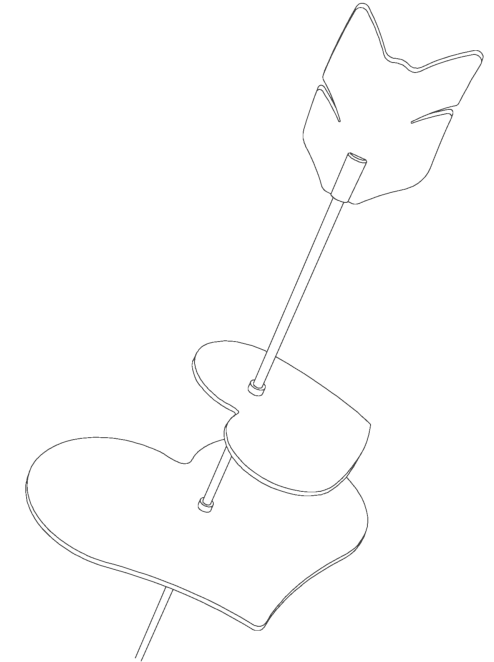

## Content

- What's in the box
- General tips
- Assembly guide
- Setting it up
- Cleaning
- More info
- Safety warnings

## What's in the box



- 1x Big heart
- 1x Small heart
- 1x Fletch
- 1x Flexible fiberglass swing rod
- 1x Assembly guide
- 1x Mounting kit

## General tips

- SunForms are generally winter-proof and can handle temperatures up to 75 °C.
- The discs come wrapped in protective film. For quality checks or with frosted, engraved, or coated discs (MultiColor), the film is removed during production.
- **To keep the film from tearing on delicate engravings or thin edges, please peel it off nice and slow.**

## Assembly Guide

To put your SunForm together, you'll need:

-  a damp cloth
-  and a tape measure.

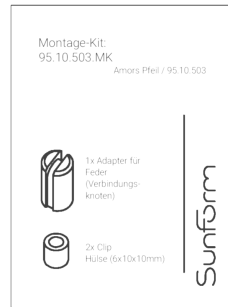

1. Twist the clips into the holes on both hearts.

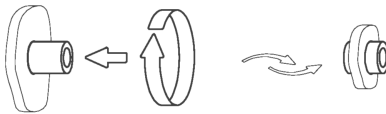

2. Wet the rod a little and twist or slide the bottom heart into place.

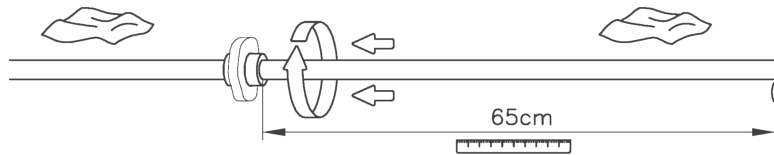

3. Do the same thing for the top heart.

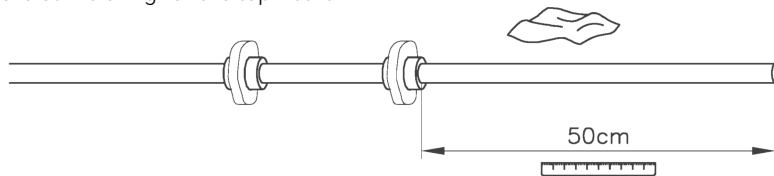

4. Push the clamp holder all the way into the slot on the fletch (4.1), then slide the whole thing onto the rod (4.2).

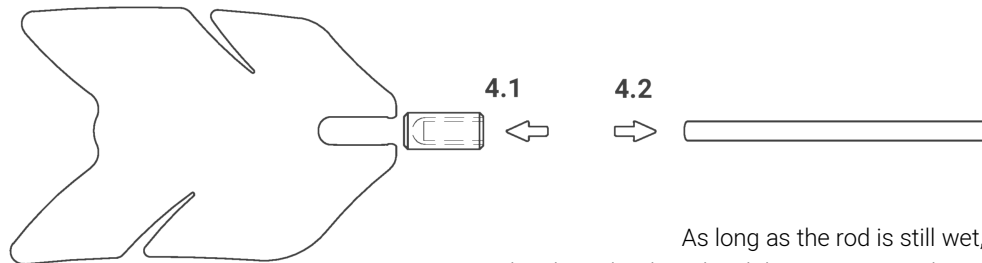

As long as the rod is still wet, you can easily adjust the discs by sliding or twisting them. After a few days, any moisture between the rod and the clips will have dried up. This is when the discs will be firmly locked into their final position.

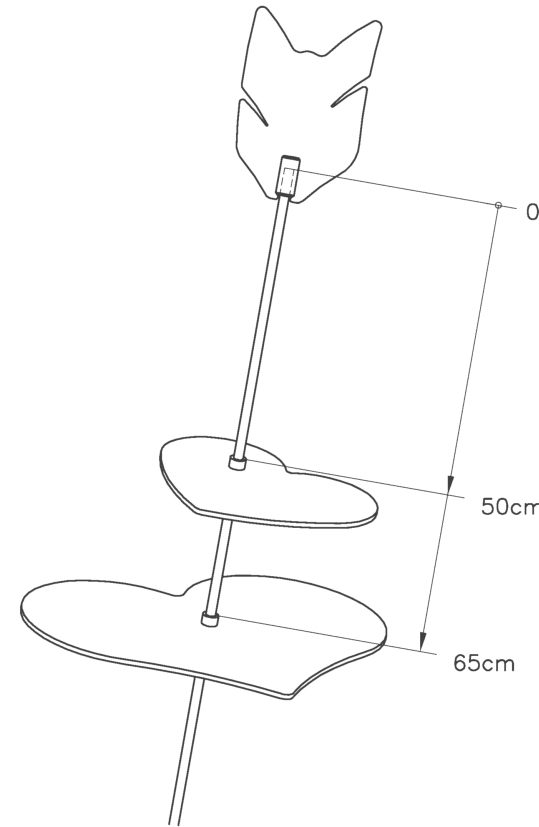

The measurements are just suggestions.

You can totally choose where the hearts go and how much space you want between them..

## Setting it up

Sun catchers actually like shady spots best. So, it's better not to place your sun catcher in direct sunlight. In direct sun, everything looks so bright that your eyes can't really pick up the subtle differences in glow anymore.

You can just stick the rod for this SunForm straight into the ground. If the ground is hard and it's not too windy, about 15 cm deep is fine. If the soil is soft or you're expecting stronger winds, the rod should go about 20 to 25 cm deep.

Make sure the vibrations don't loosen the dirt and widen the hole over time. This would make the whole thing less stable. If that happens, just pull the rod out and stick it back in a slightly different spot.